



## Applications

### Chrysler

200 .....	2011-2013
300/300C .....	2008-2010
Aspen .....	2008-2009
Sebring .....	2007-2010
Town and Country.....	2008-up

### Dodge

Avenger .....	2007-up
Caliber .....	2009-2012
Challenger .....	2008-up
Charger .....	2008-2010
Dakota .....	2008-2011
Durango .....	2008-2009
Grand Caravan .....	2008-up
Journey** .....	2009-2010
Magnum .....	2008-2009
Nitro .....	2007-2011
Ram 1500.....	2009-2011
Ram 2500/3500 .....	2010-2011

### Jeep

Compass .....	2009-up
---------------	---------

Commander .....	2008-2010
Grand Cherokee .....	2008-2010
Patriot .....	2009-up
Liberty .....	2008-2012
Wrangler**.....	2007-up

### Mitsubishi

Raider .....	2008-2009
--------------	-----------

### Ram

1500.....	2012
2500/3500 .....	2012-up
Chassis Cab .....	2012-up
C/V Tradesman .....	2012-up

### VW

Routan .....	2009-2012
--------------	-----------

## Table of Contents

### Dash Disassembly

- Chrysler Aspen 2008-2009/ Dodge Durango 2008-2009 .....	3
- Chrysler Sebring 2007-2010.....	3
- Chrysler Town and Country 2008-2010 .....	4
- Chrysler Town and Country 2011-up .....	5
- Chrysler 200 2011-2013.....	5
- Chrysler 300/300c 2008-2010.....	6
- Dodge Avenger 2008-up .....	6
- Dodge Caliber 2009-2012.....	8
- Dodge Challenger 2008-up .....	8
- Dodge Charger 2008-2010 .....	6
- Dodge Dakota 2008-2011.....	7
- Dodge Grand Caravan 2008-2010.....	4
- Dodge Grand Caravan 2011-up.....	5
- Dodge Journey 2009-2010** .....	8
- Dodge Magnum 2008-2009.....	6
- Dodge Nitro 2007-2011/ Jeep Liberty 2008-2012 .....	7
- Dodge Ram 1500 2009-2011 .....	9-10
- Dodge Ram 2500/3500 2010-2011 .....	9-10

- Dodge Ram Chassis Cab 2011 .....	9-10
- Jeep Compass 2009-up.....	8
- Jeep Patriot 2009-up .....	8
- Jeep Commander/ Grand Cherokee 2008-2010.....	11
- Jeep Wrangler 2007-up** .....	12
- Mitsubishi Raider 2008-2009.....	12
- Ram 1500 2012.....	9-10
- Ram 2500/3500 2012-up .....	9-10
- Ram Chassis Cab 2012-up.....	9-10
- Ram C/V Tradesman 2012-up .....	10
- VW Routan 2009-up.....	5



Provided for OEM Auto Parts Co  
customers only

**Caution: It is highly recommended to disconnect your vehicle's negative battery terminal prior to installation.**



## Dash Disassembly

### Chrysler Aspen 2008-2009 Dodge Durango 2008-2009

1. Unsnap and remove storage cup holder assembly. (Figure A)
2. Remove (2) screws from bottom edge of center dash trim panel. Unsnap and remove the panel. (Figure B)
3. Remove (4) screws securing the radio. Unplug and remove radio. (Figure C)

*Continue to kit assembly*

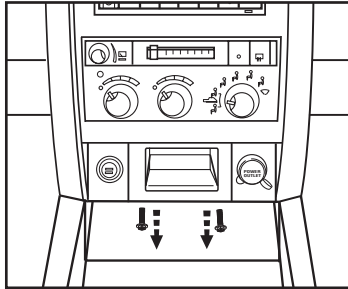

(Figure B)

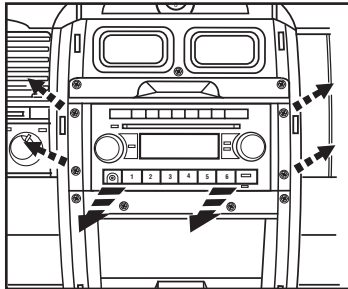

(Figure C)

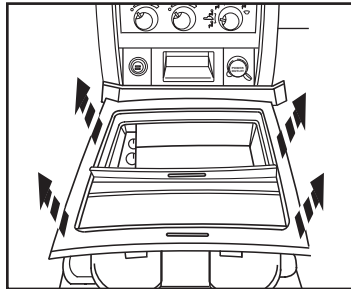

(Figure A)

### Chrysler Sebring 2007-2010

1. Unclip entire panel surrounding radio including A/C vents and clock. Unplug and remove panel. (Figure A)
2. Remove (4) 7mm screws securing radio. Unplug and remove radio. (Figure B)

*Continue to kit assembly*

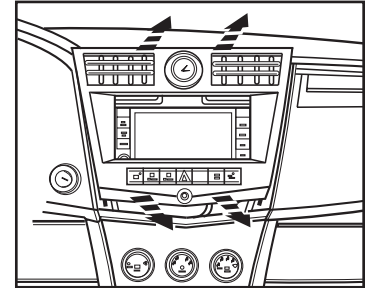

(Figure A)

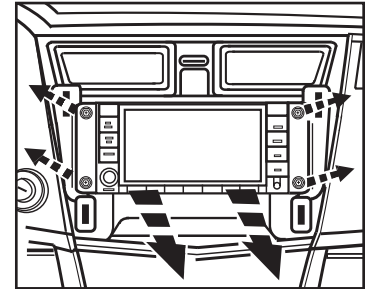

(Figure B)



## Dash Disassembly

### Chrysler Town and Country 2008-2010 Dodge Grand Caravan 2008-2010

1. Remove (2) screw covers facing up above radio then remove the (2) Phillips screws exposed. (Figure A)
2. Lift up on panel above radio then remove (2) Phillips screws exposed at front edge of radio trim panel. (Figure B)
3. Remove (3) plastic push pins per side of bottom trim panel then slide panel toward rear of van to access (2) screws on bottom of radio trim panel. (Figure C)

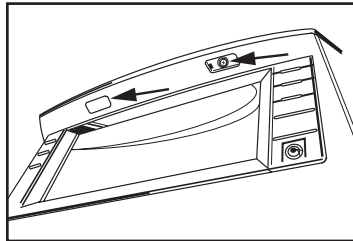

(Figure A)

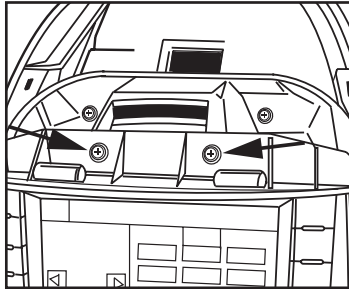

(Figure B)

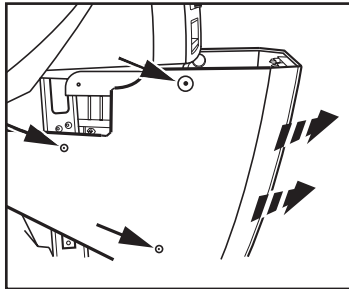

(Figure C)

4. Remove (2) Phillips screws exposed at bottom edge radio trim panel. (Figure D)
5. Unclip and remove entire panel surrounding radio including climate controls, vents and clock. (Figure E)
6. Remove (4) Phillips screws securing radio. (Figure F)

*Continue to kit assembly*

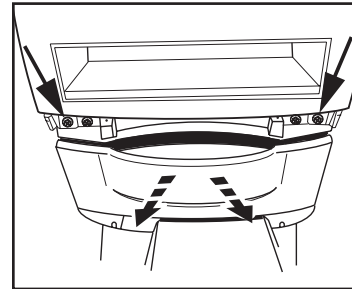

(Figure D)

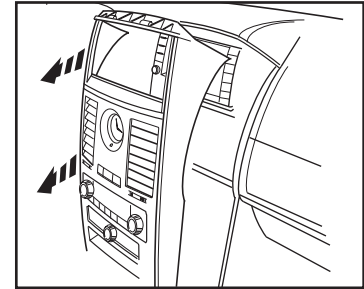

(Figure E)

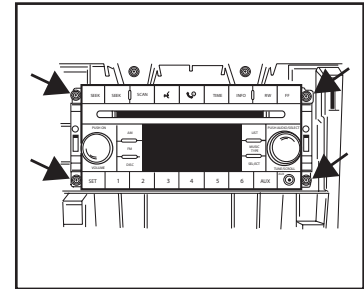

(Figure F)



## Dash Disassembly

### Chrysler Town and Country 2011-up Dodge Grand Caravan 2011-up Volkswagen Routan 2009-up

1. Unclip and remove the radio trim panel. (Figure A)
2. Remove (4) Torx securing the radio. (Figure B)

*Continue to kit assembly*

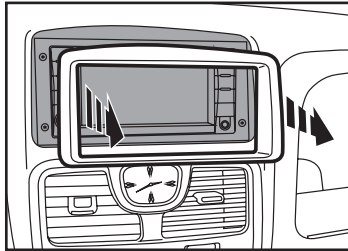

(Figure A)

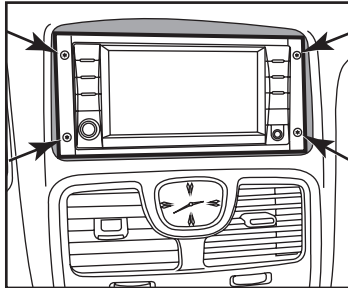

(Figure B)

### Chrysler 200 2011-2013

1. Unclip and remove the radio trim panel. (Figure A)
2. Remove (4) Torx securing the radio. (Figure B)

*Continue to kit assembly*

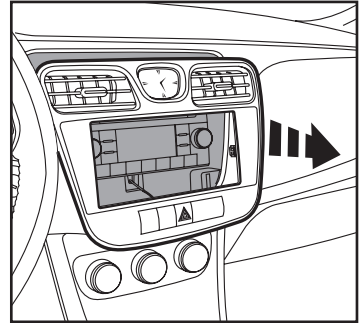

(Figure A)

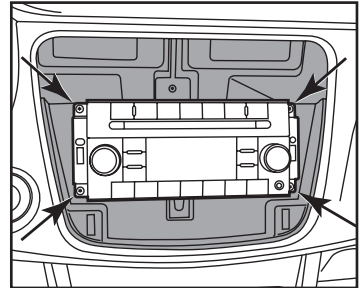

(Figure B)



## Dash Disassembly

### Chrysler 300/300C 2008-2010, Dodge Magnum 2008-2009/Charger 2008-2010

1. Unsnap and remove center dash trim panel. (Figure A)
2. Remove (4) screws securing the radio. Disconnect and remove the radio. (Figure B)

*Continue to kit assembly*

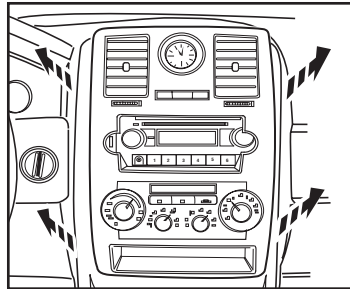

(Figure A)

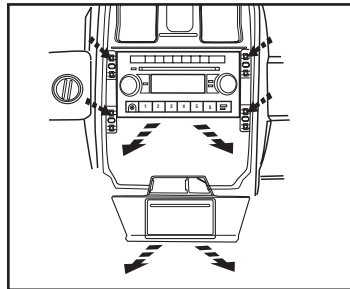

(Figure B)

### Dodge Avenger 2008-up

1. Unclip and remove the center console trim panel. (Figure A)
2. Unclip the center dash trim panel. (Figure B)
3. Remove (4) screws securing the radio. Disconnect and remove the radio. (Figure C)
4. Remove (3) screws securing the radio rear support bracket and remove the bracket. (Figure D)

*Continue to kit assembly*

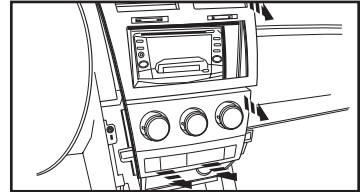

(Figure B)

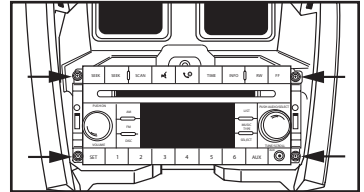

(Figure C)

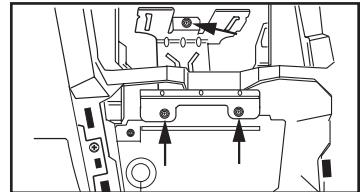

(Figure D)

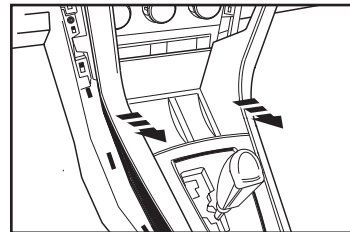

(Figure A)



## Dash Disassembly

### Dodge Dakota 2008-2011

1. Unclip and remove the trim panel surrounding the radio. (Figure A)
2. Remove (4) Phillips screws securing the radio. (Figure B)

*Continue to kit assembly*

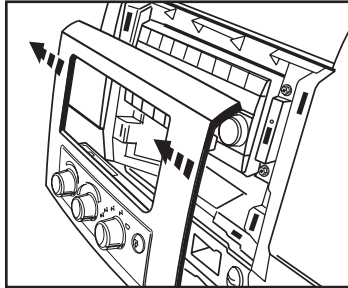

(Figure A)

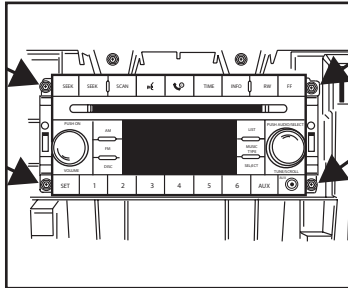

(Figure B)

### Dodge Nitro 2007-2011 Jeep Liberty 2008-2012

1. Unclip entire panel surrounding radio and climate controls, including A/C vents. Unplug and remove panel. (Figure A)
2. Remove (4) 7mm screws securing radio. Unplug and remove radio. (Figure B)

*Continue to kit assembly*

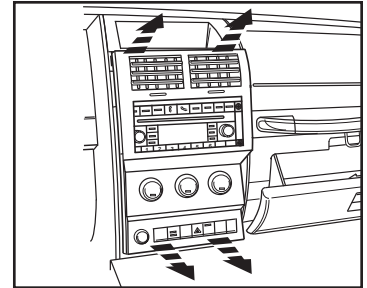

(Figure A)

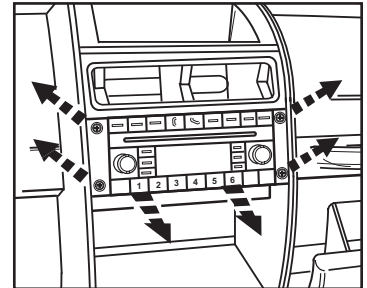

(Figure B)



## Dash Disassembly

### Dodge Journey 2009-2010

1. Unclip and remove the entire factory radio trim panel including the A/C controls. (Figure A)

**TIP: Open the compartment door at the top of the radio trim panel.**

2. Remove (4) 7mm screws securing radio to dash to remove. (Figure B)

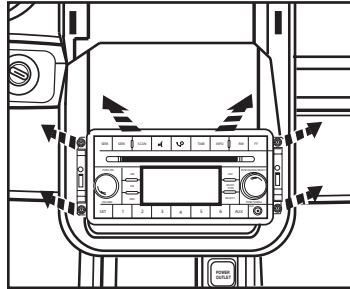

(Figure B)

*Continue to kit assembly*

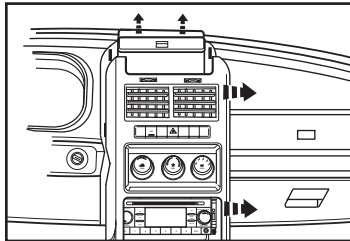

(Figure A)

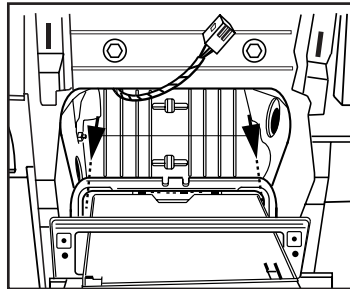

(Figure C)

### Dodge Caliber 2009-2012/Challenger 2008-up, Jeep Compass/Patriot 2009-up

1. Unsnap and move shifter trim to the side. (Figure A)
2. Unsnap center dash trim panel (do not remove until climate controls are removed). (Figure A)
3. Remove (4) Phillips screws holding climate control panel to backside of the center dash panel.
4. Remove (4) 7mm screws securing radio. Unplug and remove radio.
5. The metal bracket in the sub-dash will need to be removed for the aftermarket Double DIN radio's depth.

*Continue to kit assembly*



(Figure A)



## Dash Disassembly

### Dodge Ram 1500 2009-2011, Dodge Ram 2500/3500 2010-2011, Dodge Ram Chassis Cab 2011, Ram 1500 2012, Ram 2500/3500 2012-up, Ram Chassis Cab 2012-up

1. Remove (1) T25 Torx screw in the compartment next to the cup holders. (Figure A)
2. Remove (2) Phillips screws in the pocket below the climate control in the front of the center console. (Figure B)
3. Remove (2) 9/32" screws in the cup holders. (Figure C)

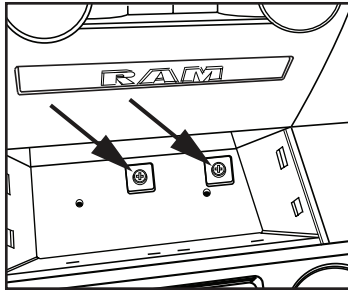

(Figure B)

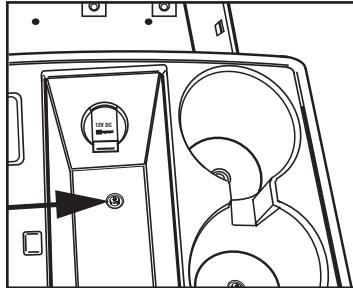

(Figure A)

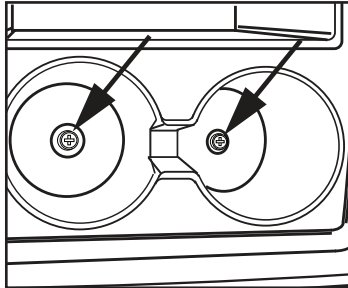

(Figure C)

4. Push down on the collar below the shifter then pull the shifter straight up to remove. (Figure D)
5. Unclip and remove the top of the center console including the cup holders. (Figure E)
6. Unclip and remove the trim panel from the accessory socket on the radio trim panel, then remove (1) T25 Torx screw. (Figure F)

*Continued on next page*

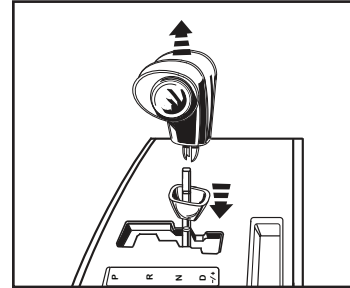

(Figure D)

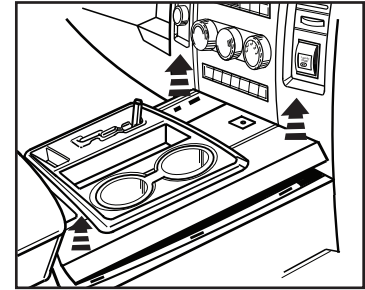

(Figure E)

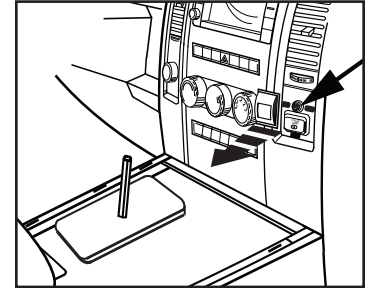

(Figure F)





## Dash Disassembly

### Dodge Ram 1500 2009-2011, Dodge Ram 2500/3500 2010-2011, Dodge Ram Chassis Cab 2011, Ram 1500 2012, Ram 2500/3500 2012-up, Ram Chassis Cab 2012-up

7. Remove (2) T25 Torx screws from the top of the radio trim panel. (Figure G)
8. Unclip and remove the entire radio trim panel including the climate controls. (Figure H)
9. Remove (4) 9/32" screws securing the radio. (Figure I)

*Continue to kit assembly*

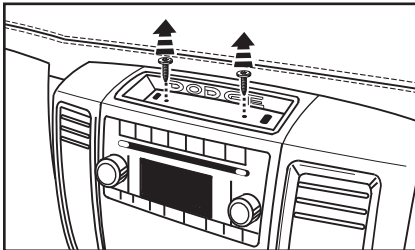

(Figure G)

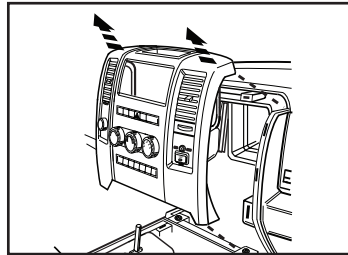

(Figure H)

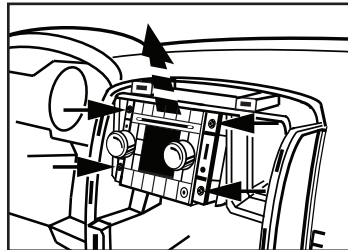

(Figure I)

### Ram C/V Tradesman 2012-up

1. Remove the radio trim bezel. (Figure A)
2. Remove (4) screws securing the radio to the dash. (Figure B)

*Continue to kit assembly*

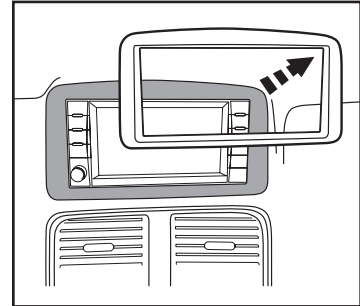

(Figure A)

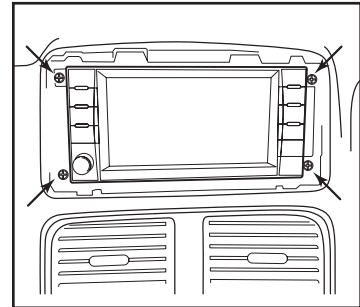

(Figure B)



## Dash Disassembly

### Jeep Commander/Grand Cherokee 2008-2010

1. Unsnap and remove the small trim around the console shifter. (Figure A)
2. Unsnap and remove the larger trim around the console shifter. (Figure B)
3. Remove (1) Phillips screw from inside the small storage pocket in the lower dash, between the power outlets. (Figure C)
4. Unsnap and remove the dash panel from around the radio (including climate controls). (Figure D)
5. Remove (4) Phillips screws securing the radio. Unplug and remove radio.  
Continue to kit assembly

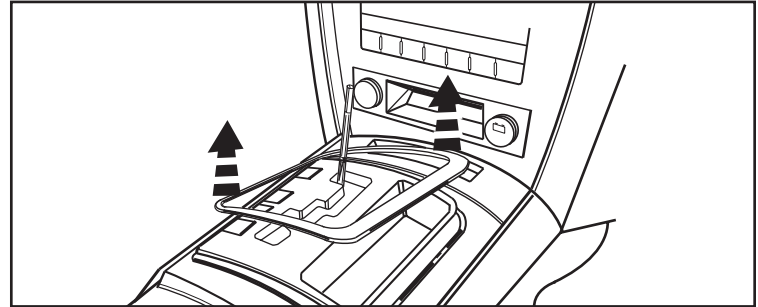

(Figure A)

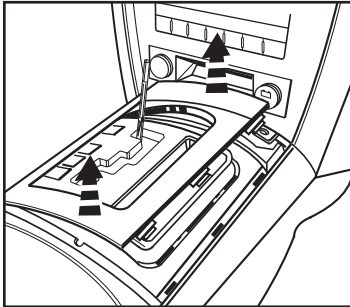

(Figure B)

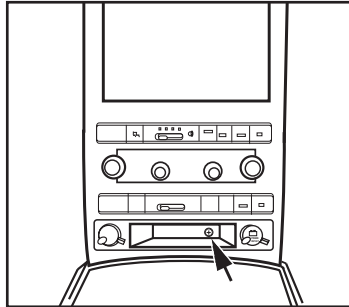

(Figure C)

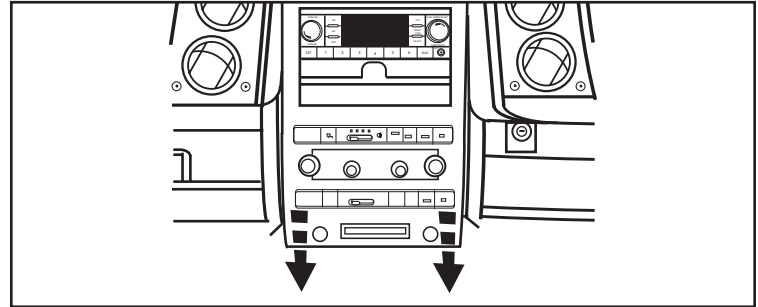

(Figure D)



## Dash Disassembly

### Jeep Wrangler 2007-up

1. Unclip and remove the lower center trim below A/C controls. (Figure A)
2. Remove (2) Phillips screws exposed behind lower center panel. (Figure A)
3. Unclip and remove the upper center trim starting towards the rear of the panel. (Figure A)
4. Remove (2) Phillips screws exposed behind upper center panel. (Figure A)
5. Unclip and remove entire panel surrounding radio and climate controls, including A/C vents.
6. Remove (4) 7mm screws securing radio. Unplug and remove radio. (Figure B)

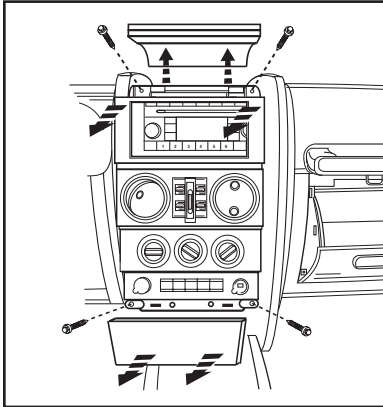

(Figure A)

*Continue to kit assembly*

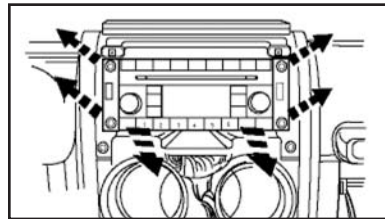

(Figure B)

### Mitsubishi Raider 2008-2009

1. Unsnap and remove center dash panel. (Figure A)
2. Remove (4) 7mm screws securing the radio. Unplug and remove radio.

*Continue to kit assembly*

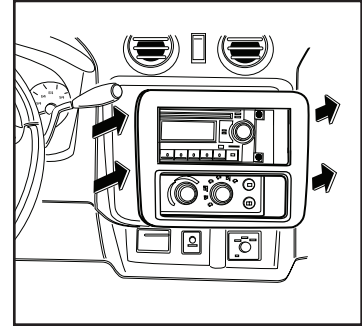

(Figure A)