



Follow the instructions within this manual to remove your factory radio. Once removed, proceed with the navigation radio installation.

Refer to our YouTube demonstration video or our in-depth installation guide located within the navigation radio's product page (on our website).



Applications

Buick		GMC	
Enclave	2008-2012	Acadia	2007-2012
Lucerne	2006-2011	Savanna	2008-up
Chevrolet		Sierra**	2007-up
Avalanche	2007-up	Yukon XL Denali	2007-up
Equinox	2007-2009	Yukon/XL	2007-up
Express Van	2008-up	Hummer	
Impala	2006-up	H2	2008-2009
Monte Carlo	2006-2007	Pontiac	
Silverado**	2007-up	Torrent	2007-2009
Suburban	2007-up	Saturn	
Tahoe	2007-up	Outlook	2007-2010
Traverse	2009-up	Vue	2008-2010
Captiva Sport	2012	Suzuki	
		XL-7	2007-2009

**Excluding classic models

Table of Contents

Dash Disassembly	
- Buick Enclave 2008-2012	6
- Buick Lucerne 2006-2011	3
- Chevrolet Avalanche 2007-up	3

Table of Contents

- Chevrolet Captiva Sport 2012	7
- Chevrolet Equinox 2007-2009	5-6
- Chevrolet Express Van (full size) 2008-up	4
- Chevrolet Impala 2006-up	3
- Chevrolet Monte Carlo 2006-2007	3
- Chevrolet Silverado Pickup (excluding classic models) 2007-up	3
- Chevrolet Suburban 2007-up	3
- Chevrolet Tahoe 2007-up	3
- Chevrolet Traverse 2009-up	6
- GMC Acadia 2007-2012	6
- GMC Savanna Van (full size) 2008-2010	4
- GMC Sierra (excluding classic models) 2007-up	3
- GMC Yukon/Yukon XL/Yukon XL Denali 2007-up	3
- Hummer H2 2008-2009	7
- Pontiac Torrent 2007-2009	5-6
- Saturn Outlook 2007-2010	6
- Saturn Vue 2008-2010	7
- Suzuki XL-7 2007-2009	4-5

Caution: It is highly recommended to disconnect your vehicle's negative battery terminal prior to installation.



Dash Disassembly

Buick Lucerne 2006-2011, Chevy Impala 2006-up, Monte Carlo 2006-2007

1. Unclip and remove the trim panel around radio and A/C control. (Figure A)
2. Remove (6) 9/32" screws to extract radio and A/C control from sub dash. (Figure B)

Continue to kit assembly



(Figure A)

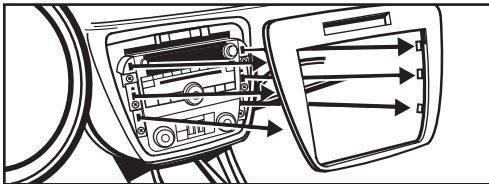

(Figure B)

Chevy Avalanche/Tahoe/Suburban/Silverado (excluding classic models) 2007-up, GMC Yukon/Sierra (excluding classic models) 2007-up

1. Unclip and remove radio trim panel. (Figure A)
2. Remove (2) 8 mm screws securing switch panel below climate controls. Unplug and remove switch panel. (Figure B)
3. Remove (2) 8 mm screws securing climate controls. Unplug and remove climate controls. (Figure B)
4. Remove (4) 9/32" screws securing radio. Unplug and remove the radio. (Figure C)

Continue to kit assembly

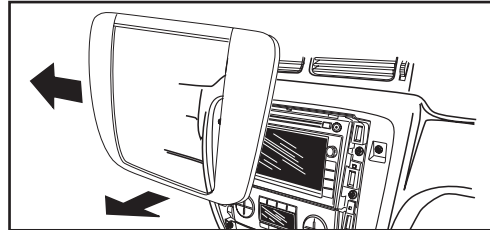

(Figure A)

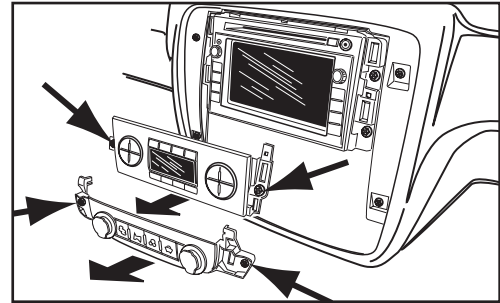

(Figure B)

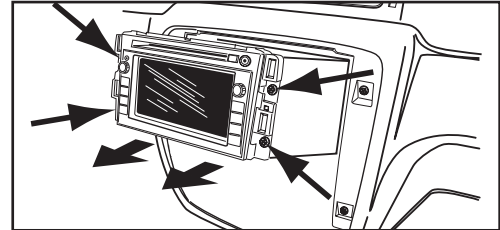

(Figure C)



Dash Disassembly

Chevy Express Van/GMC Savanna 2008-up

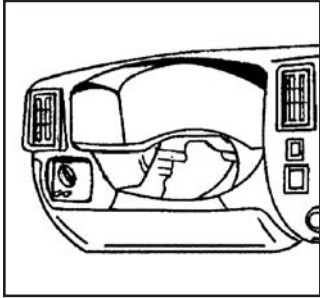

(Figure A)

1. Remove (2) 10 mm bolts from below knee bolster under steering column and remove panel.
2. Remove (2) 10 mm bolts from panel below passenger dash airbag and remove panel.
3. Unsnap and remove radio and instrument cluster panel.

Note: To access radio it may not be necessary to completely remove radio and instrument cluster panel.

4. Remove (4) 9/32" bolts to remove radio.

Continue to kit assembly

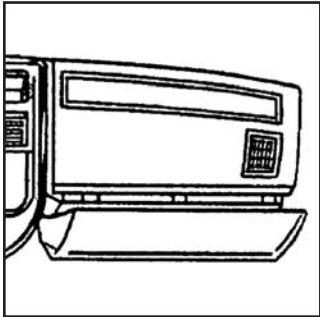

(Figure B)

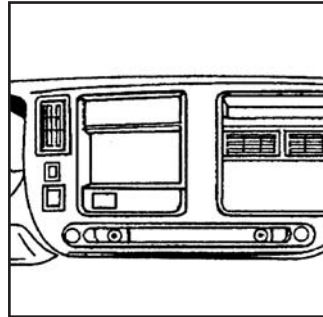

(Figure C)

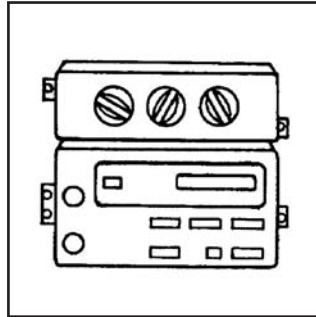

(Figure D)

Suzuki XL-7 2007-2009

1. Press in on sides of the shifter boot to release it from the shifter trim panel. (Figure A)
2. Lift the boot up to access the Allen screw securing the shifter knob to the shifter lever. Loosen the Allen screw and remove the shifter knob. (Figure B)
3. Remove (1) Torx screw from the shifter trim panel

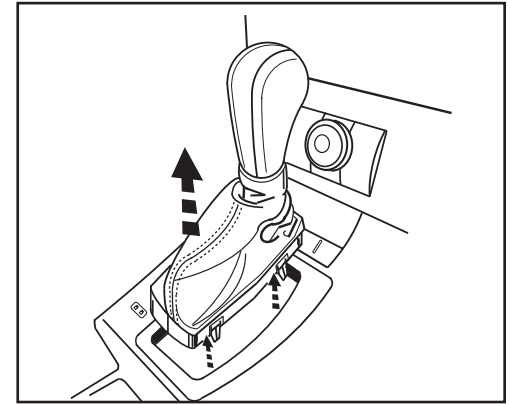

(Figure A)



Dash Disassembly

Suzuki XL-7 2007-2009

(Figure C), then using the panel removal tool unsnap the shifter trim panel. Unplug and remove the panel. (Figure D)

- Using a panel removal tool unsnap the radio trim panel. Unplug and remove the panel. (Figure E)
- Remove (4) 9/32" screws securing the radio. Unplug and remove the radio.

Continue to kit assembly

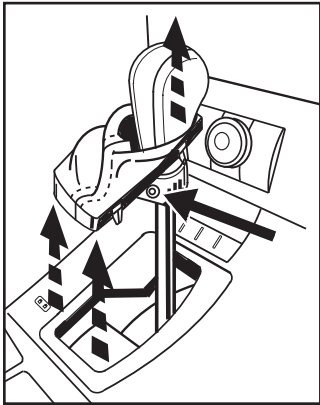

(Figure B)

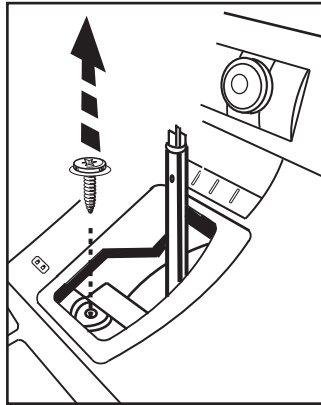

(Figure C)

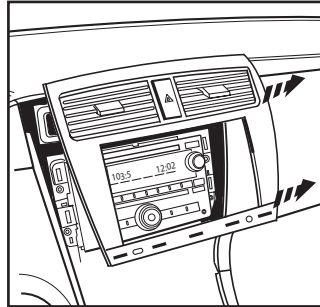

(Figure E)

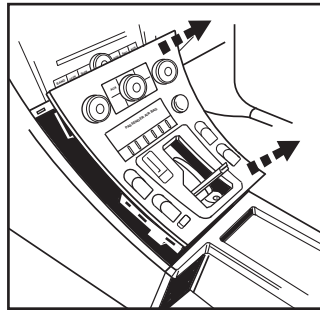

(Figure D)

Chevy Equinox/Pontiac Torrent 2007-2009

- Unsnap panel below power window switch and remove. (Figure A)

Note: This allows you to unplug the window switch easier.

- Unsnap and remove entire panel surrounding radio and shifter. (Figure B, next page)
- Remove (4) 9/32" screws securing radio. Unplug and remove the radio. (Figure C, next page)

Continue to kit assembly

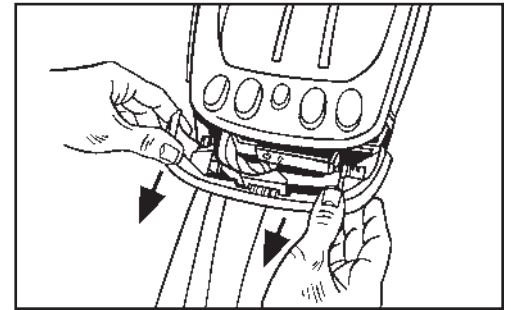

(Figure A)



Dash Disassembly

Chevy Equinox/Pontiac Torrent 2007-2009

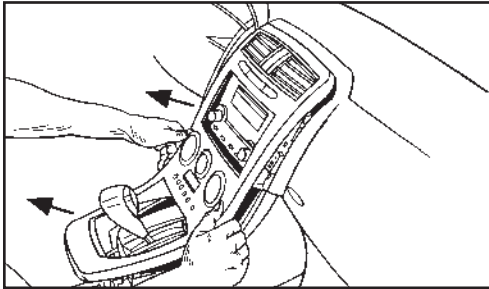

(Figure B)

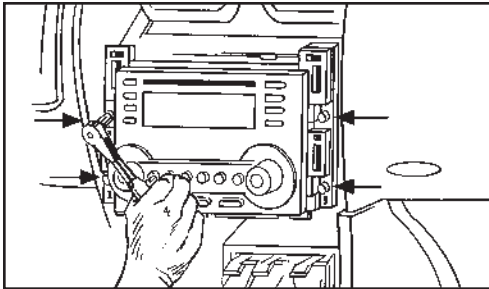

(Figure C)

Buick Enclave 2008-2012/GMC Acadia 2007-2012, Saturn Outlook 2007-2010, Chevy Traverse 2009-up

1. Unclip the radio trim panel including the climate controls.
2. Unplug the climate controls and remove the panel.
3. Remove (4) 9/32" screws securing the radio. Unplug and remove the radio.

Continue to kit assembly

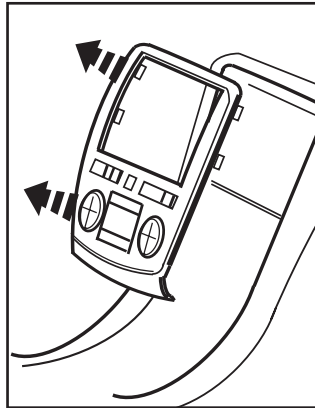

Buick Enclave/Chevy Traverse

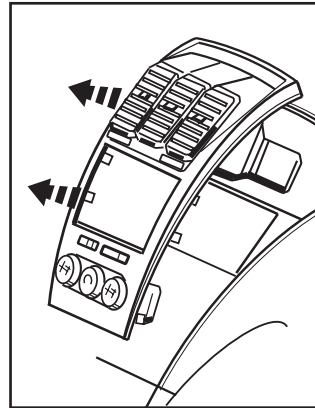

GMC Acadia

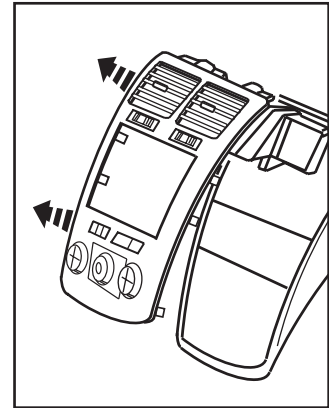

Saturn Outlook



Dash Disassembly

Hummer H2 2008-2009

1. Unclip the radio trim panel including the A/C vents.
2. Unplug any harnesses connected to the panel and remove the panel. (Figure A)
3. Remove (4) 9/32" screws securing the climate controls.
4. Unplug and remove the climate controls.
5. Remove (4) 9/32" screws securing the radio. Unplug and remove the radio.

Continue to kit assembly

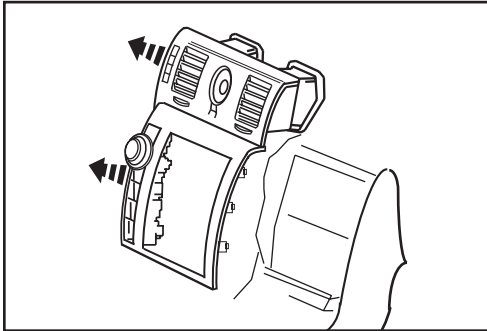

(Figure A)

Saturn Vue 2008-2010/Chevrolet Captiva 2012

1. Unclip and remove the trim panel on top of the radio trim panel. (Figure A)
2. Remove (2) Phillips screws exposed under panel previously removed. (Figure B)
3. Unclip and remove the radio trim panel including the A/C vents. (Figure B)
4. Unclip and remove the trim panel surrounding the shifter including the climate controls. (Figure C)
5. Remove (4) 9/32" screws securing the radio. Unplug and remove the radio.

Continue to kit assembly

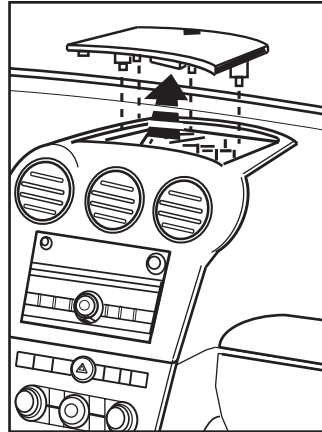

(Figure A)

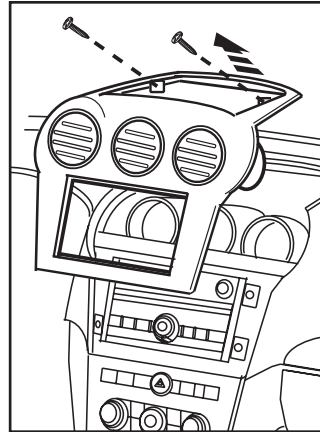

(Figure B)

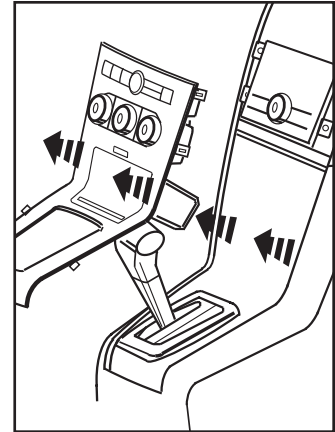

(Figure C)